

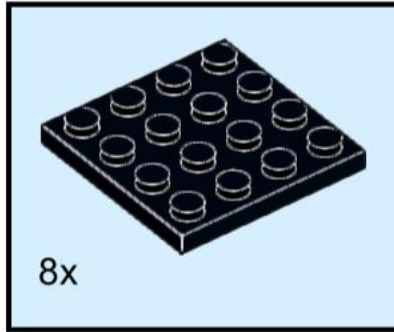

1

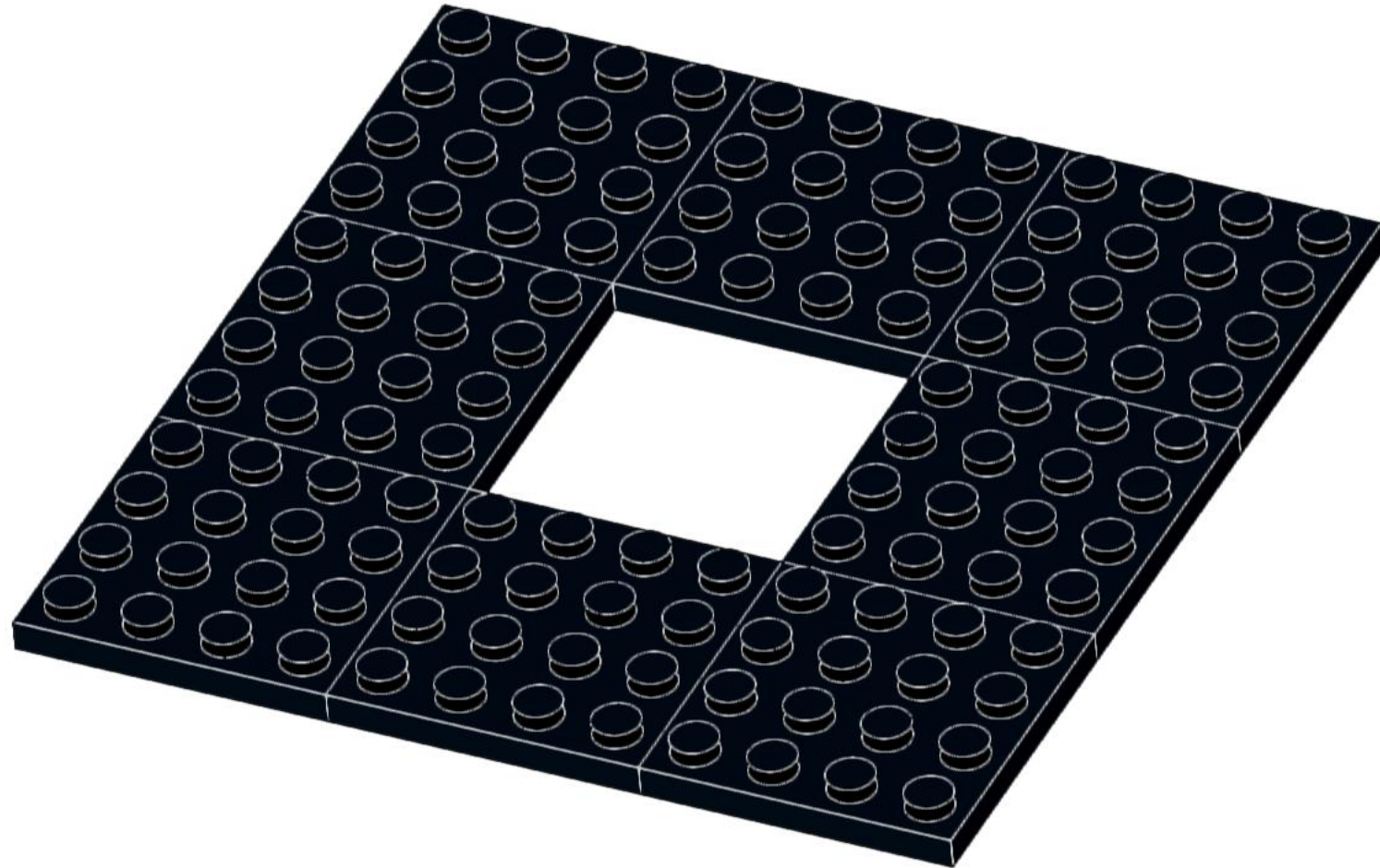

It is advised to step 1 - 4 on a flat surface.



2

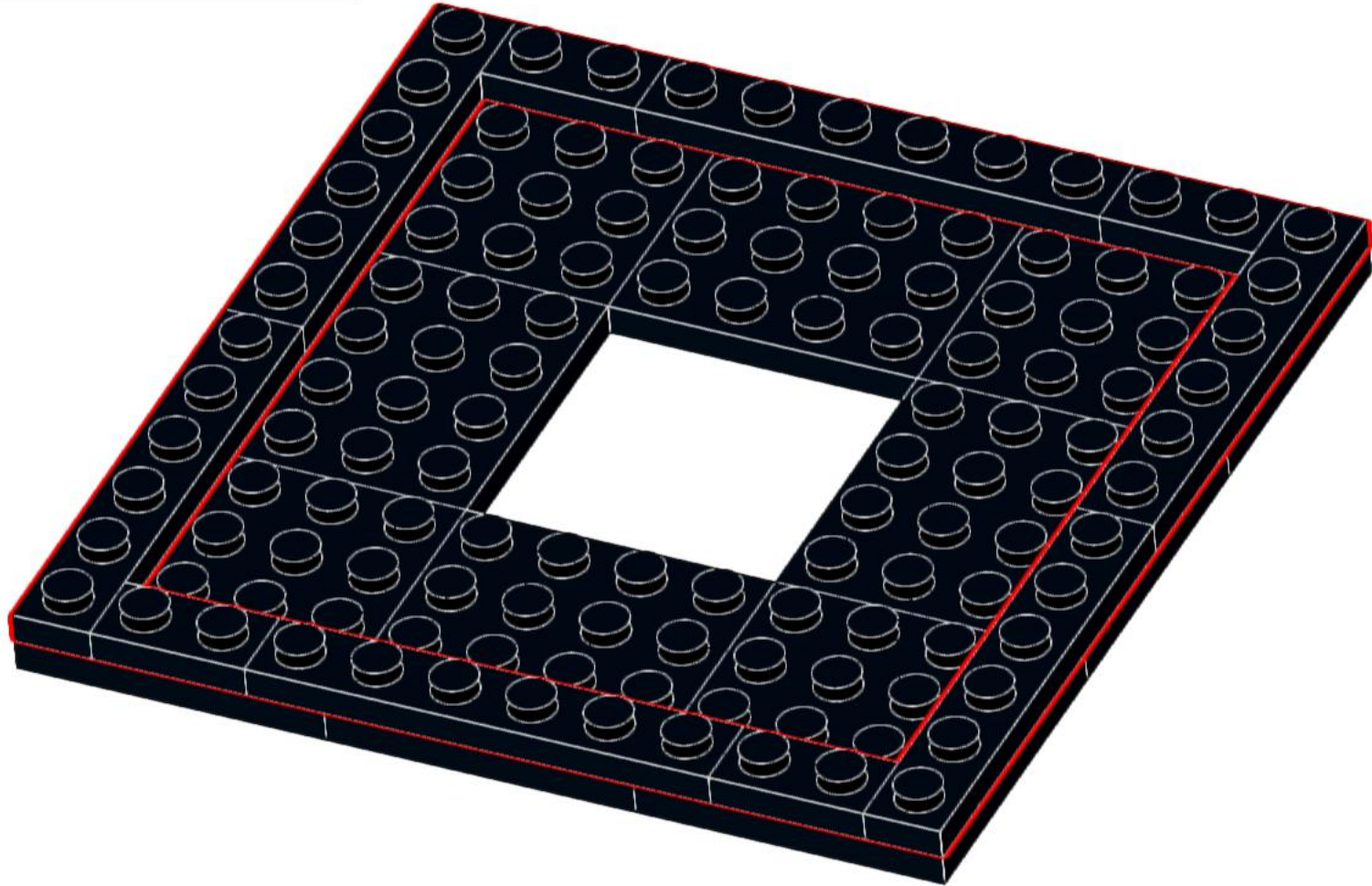
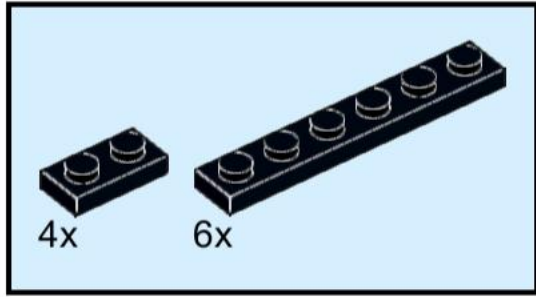

3

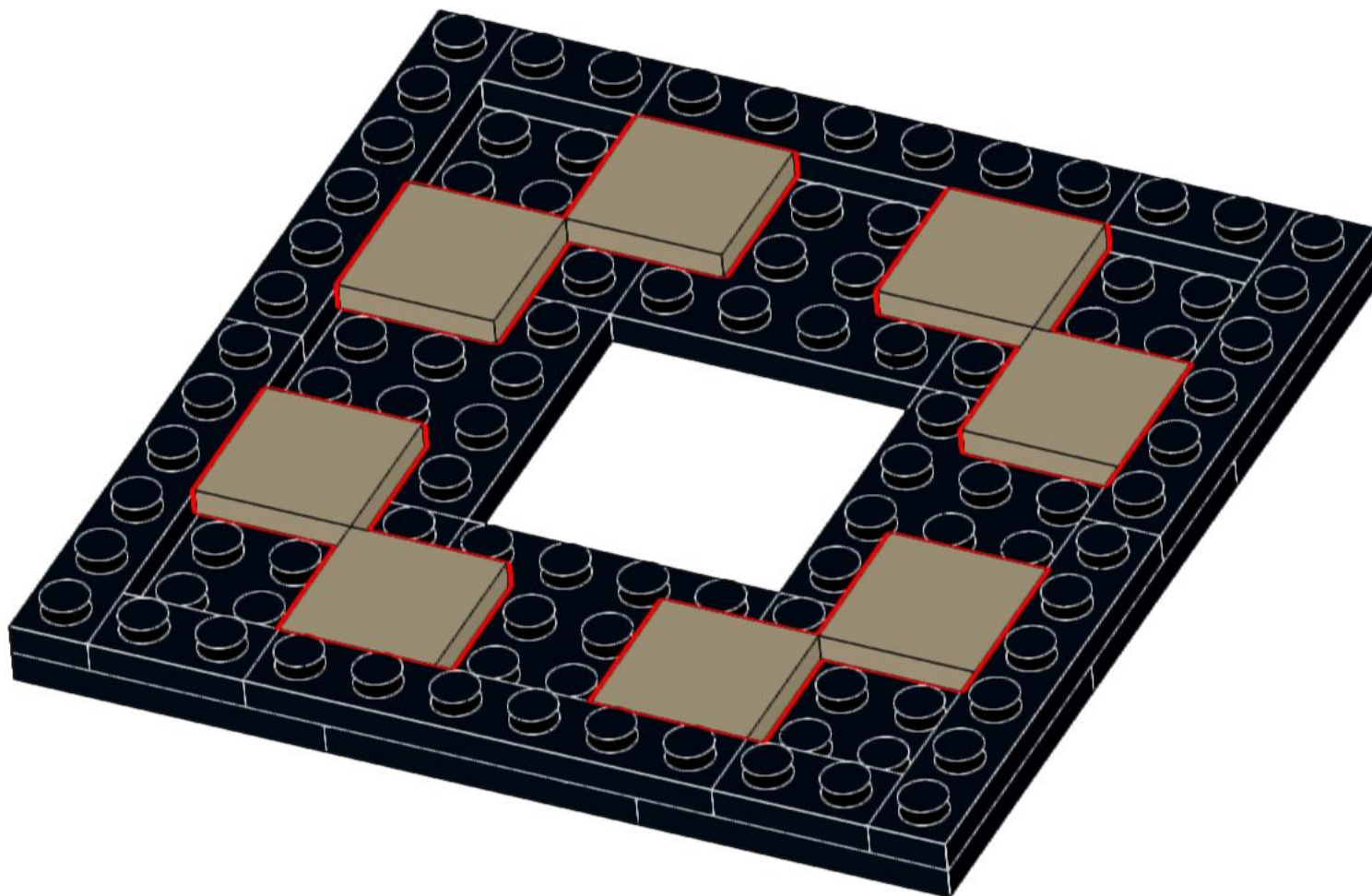
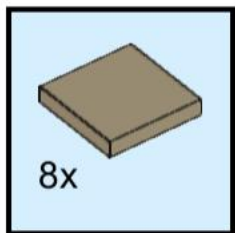

4

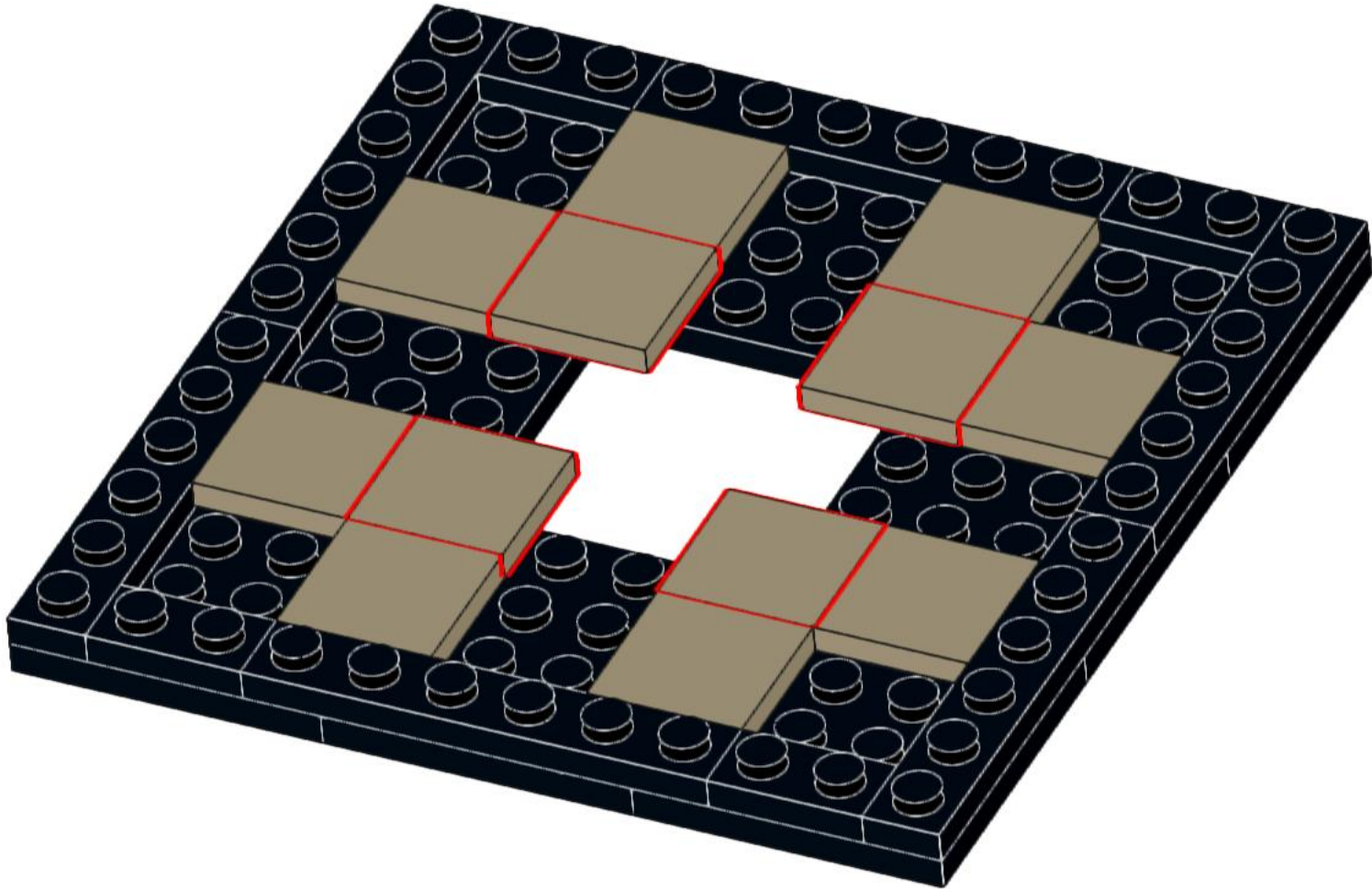
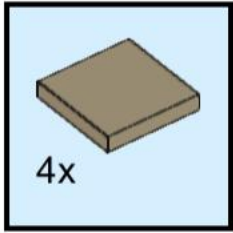

5

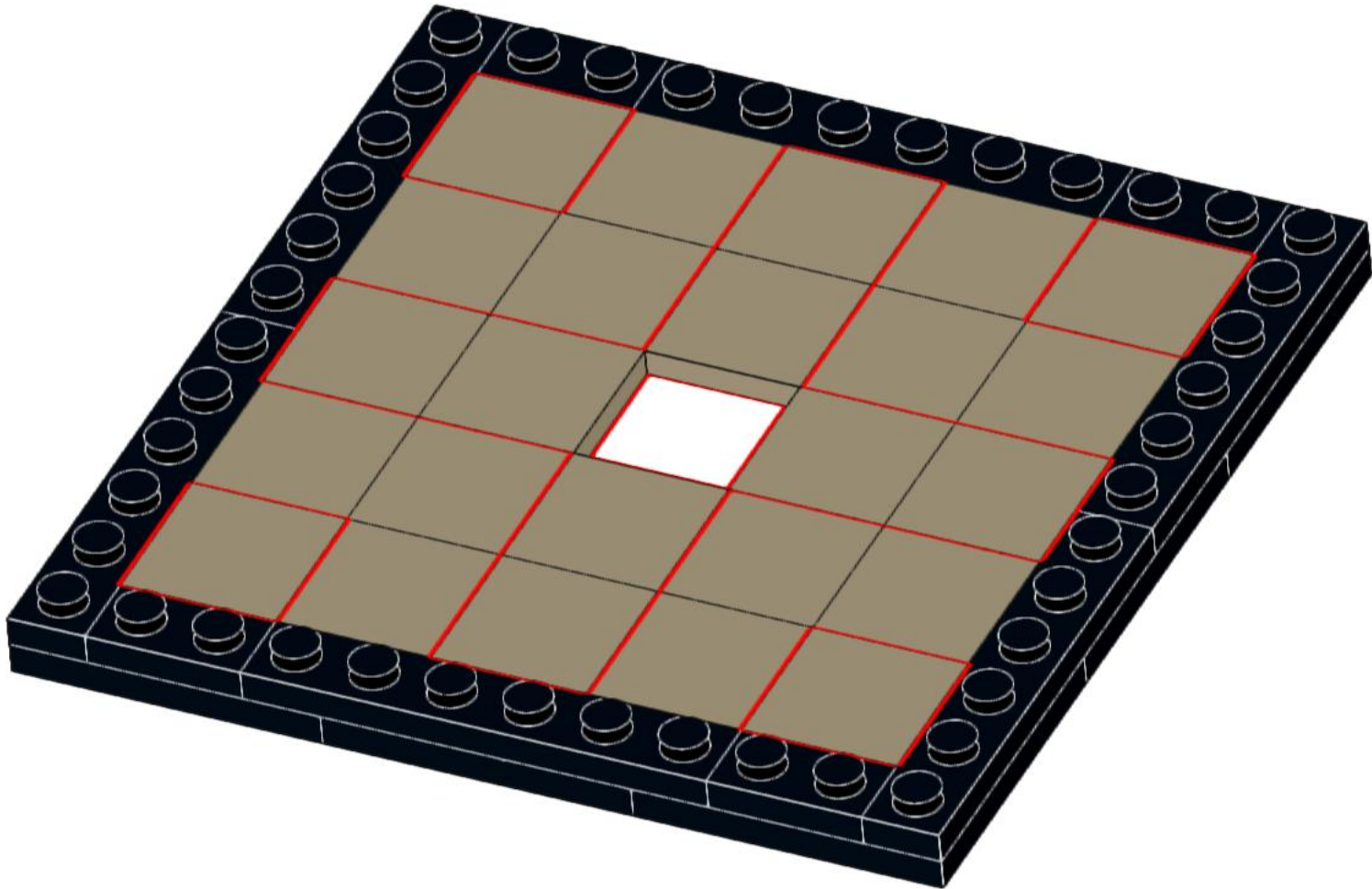
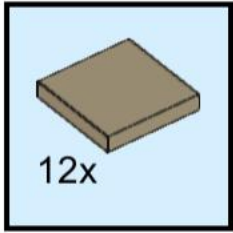

6

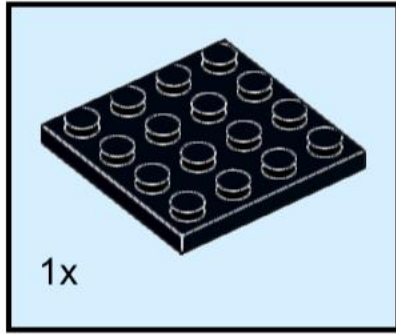

7

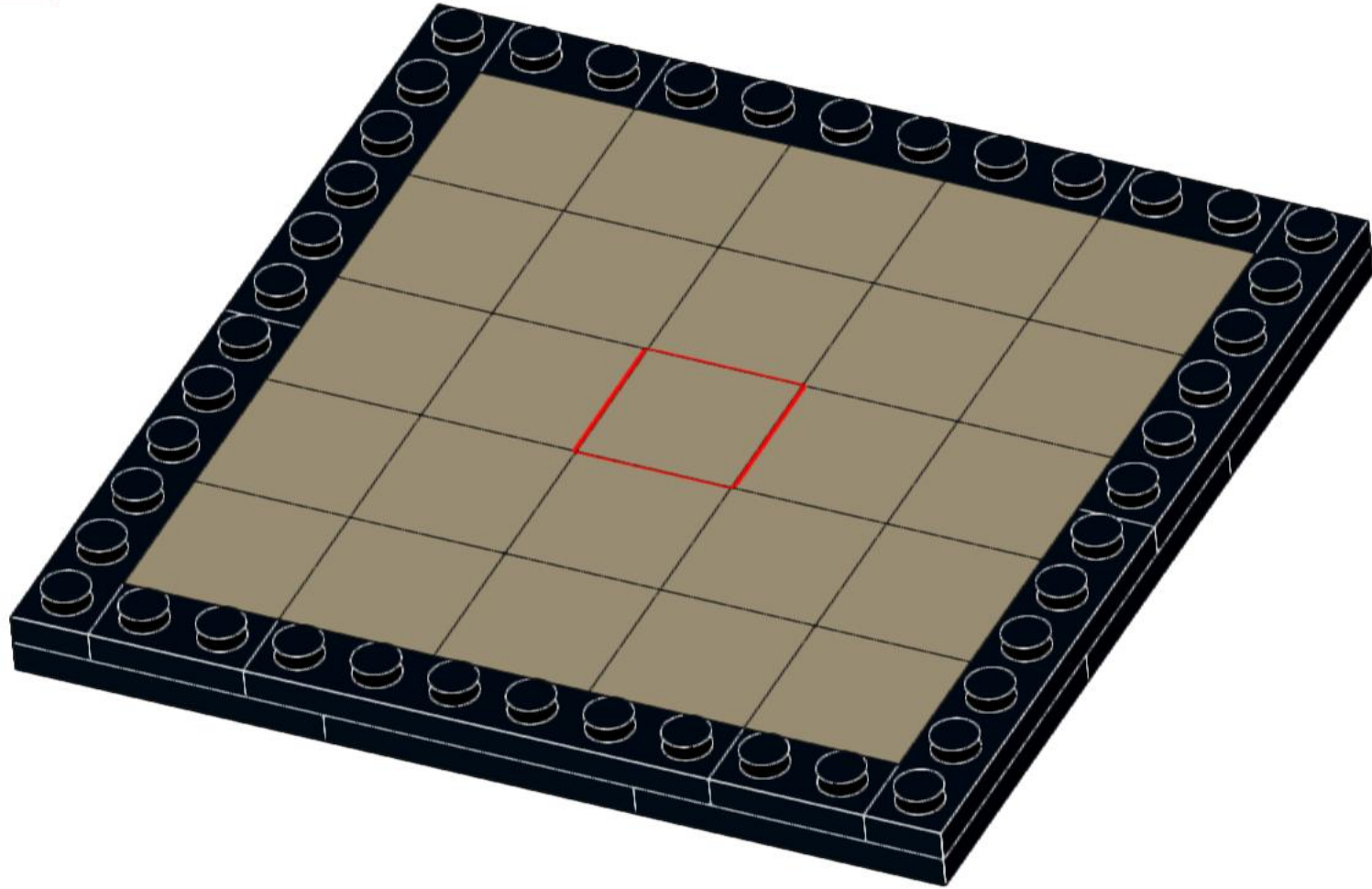
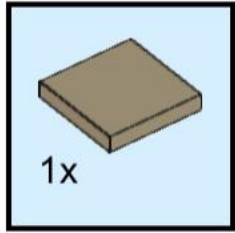

8

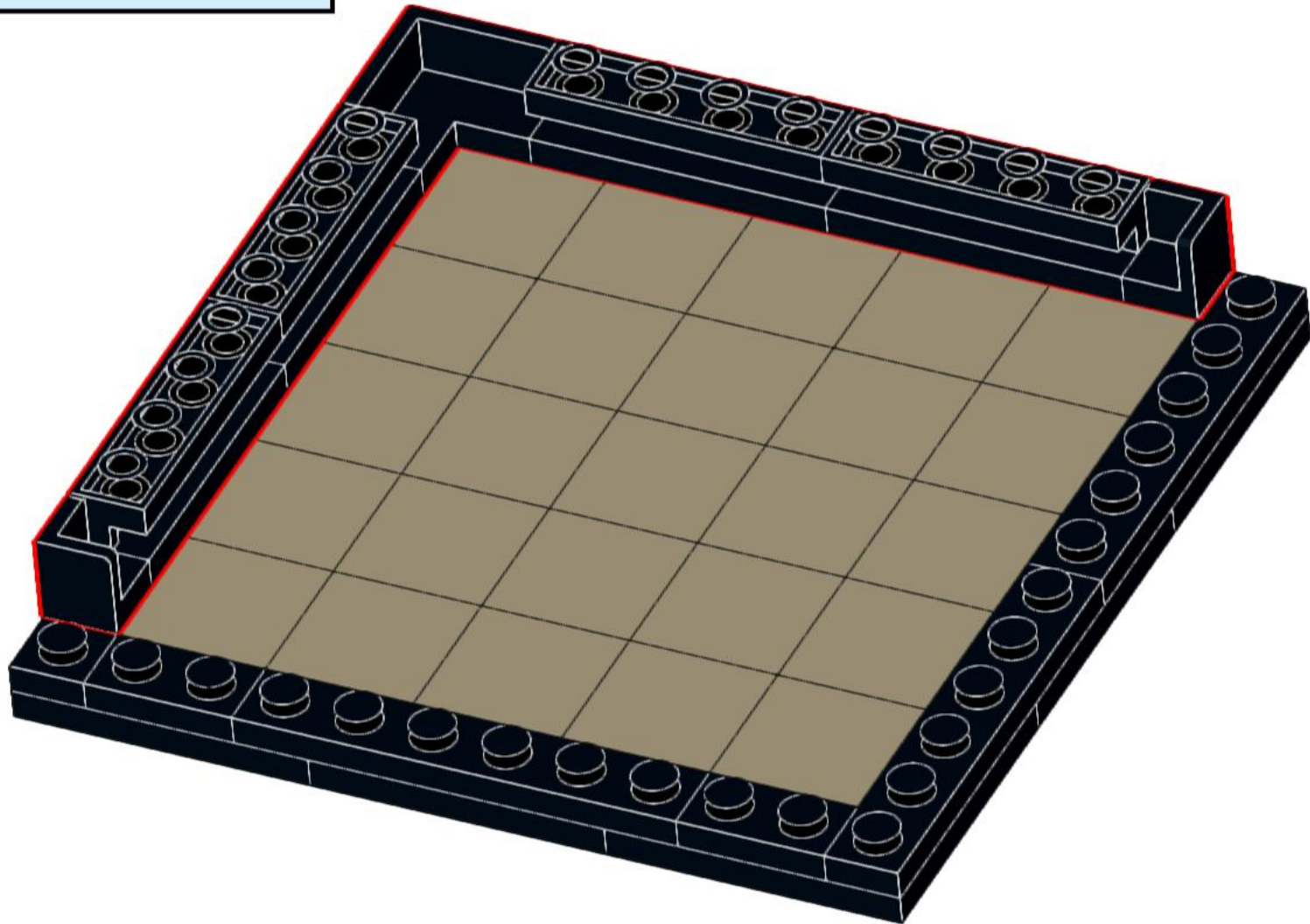
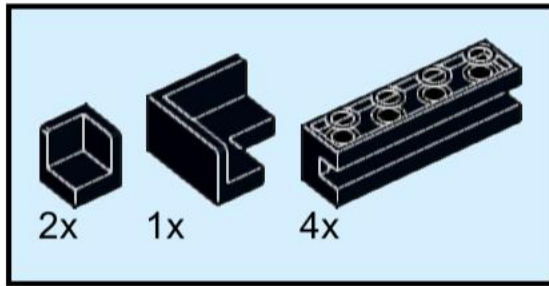

9

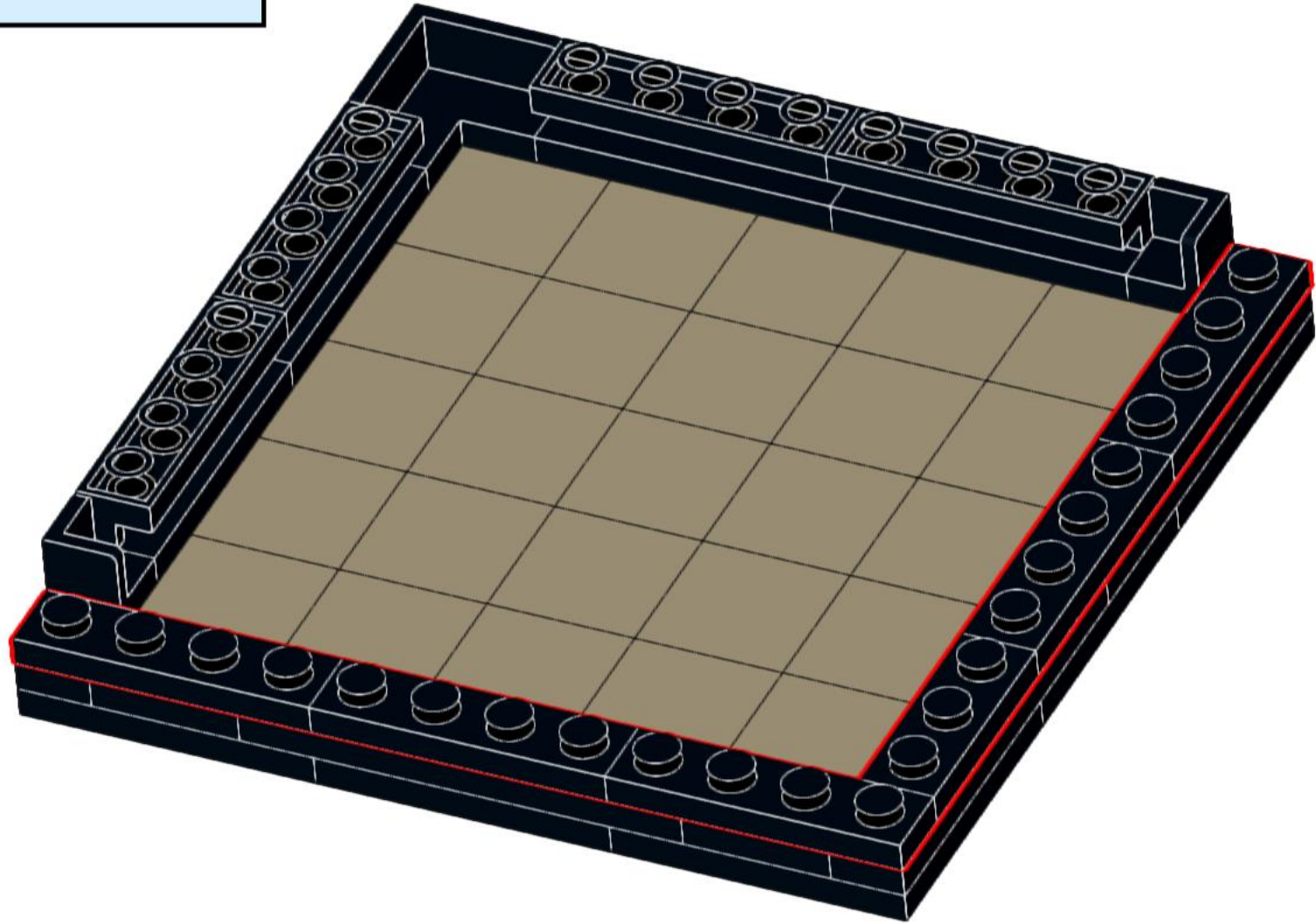
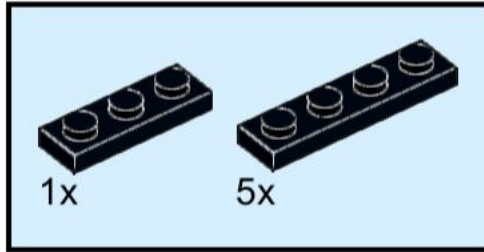

10

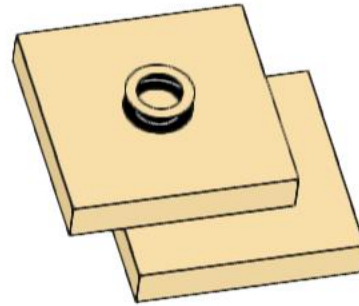
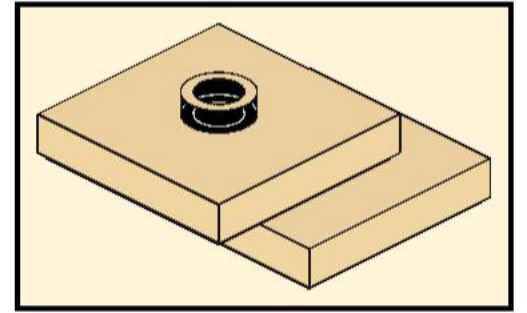
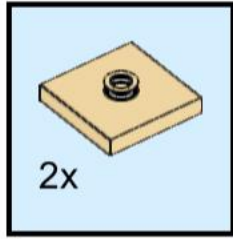

11

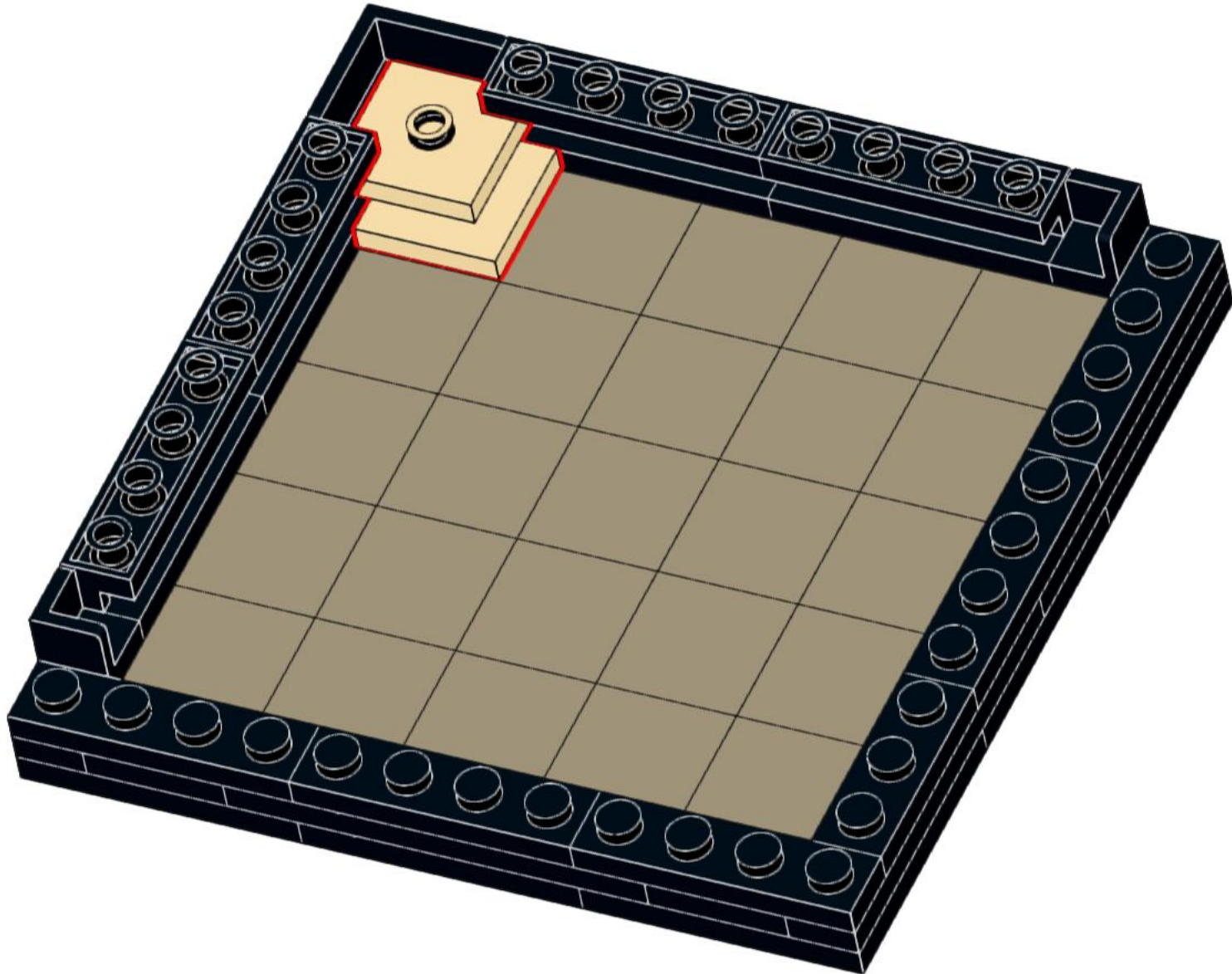

12

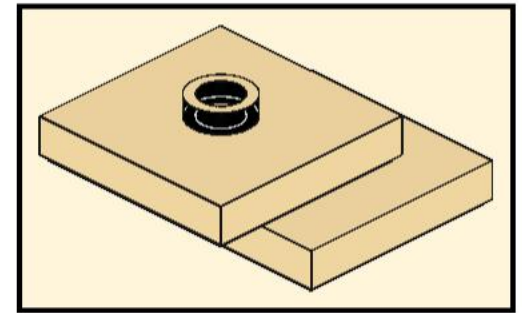
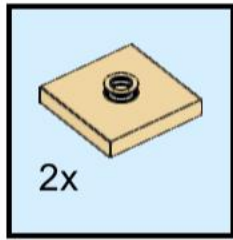

3x

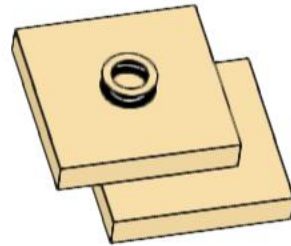

13

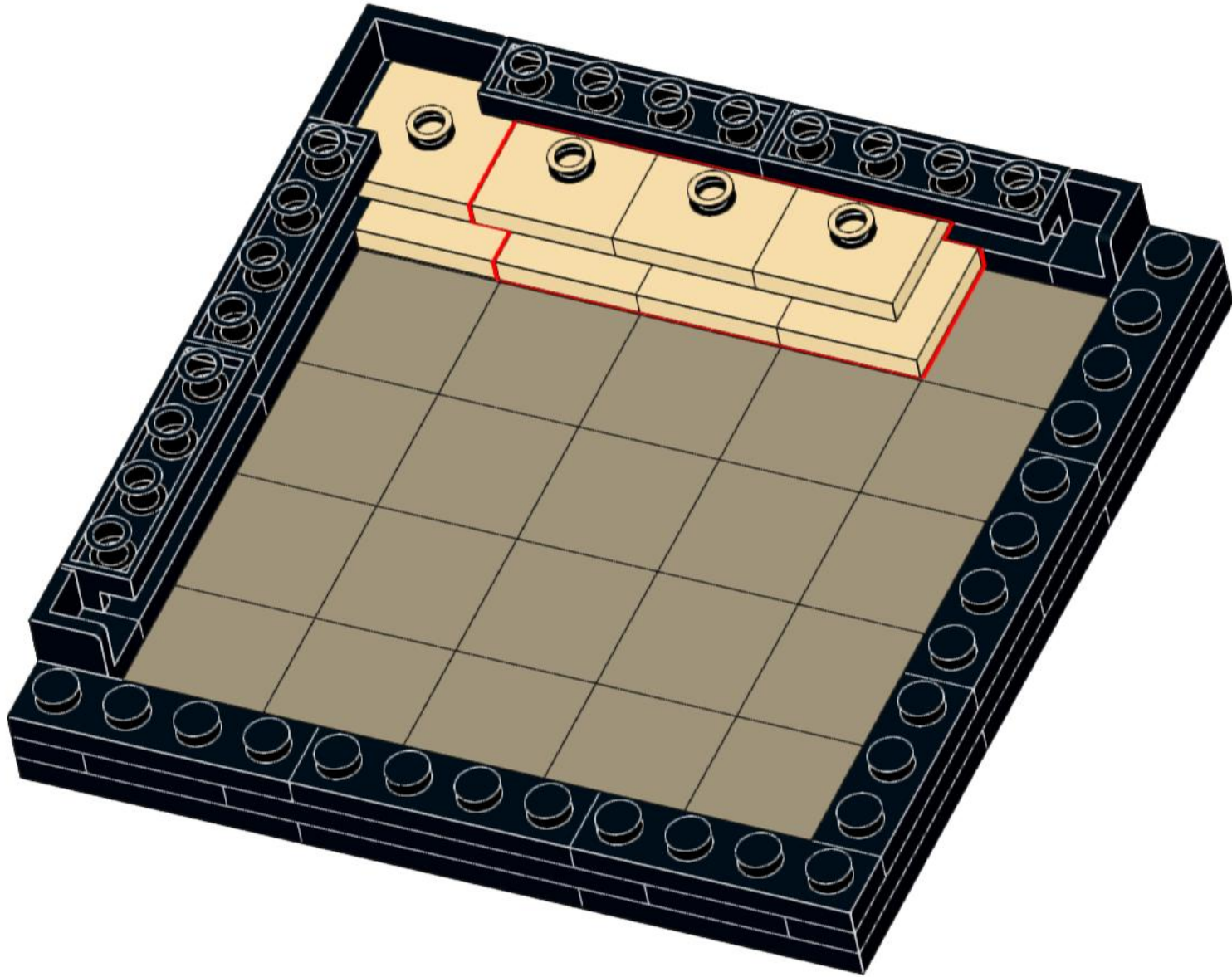

14

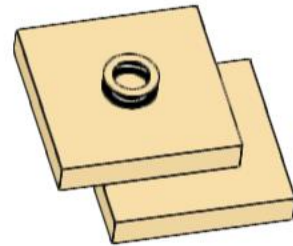
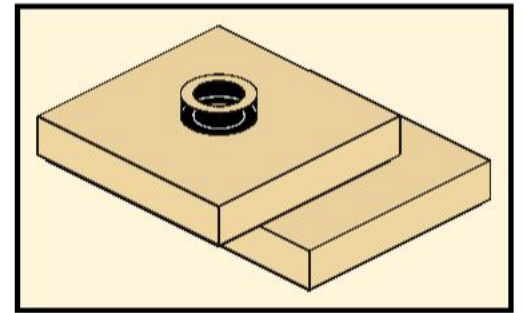
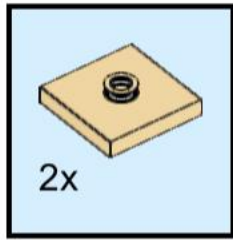

15

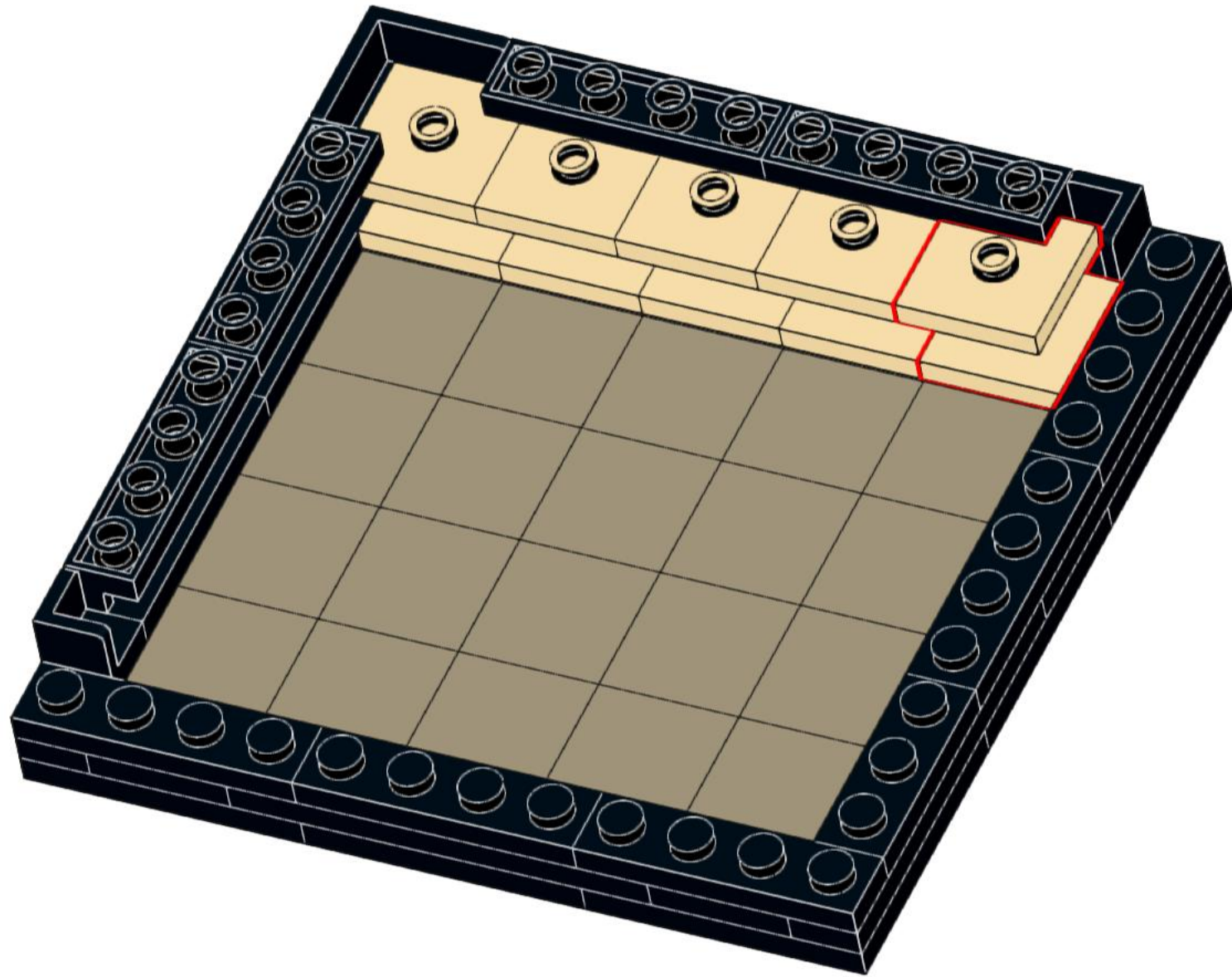

16

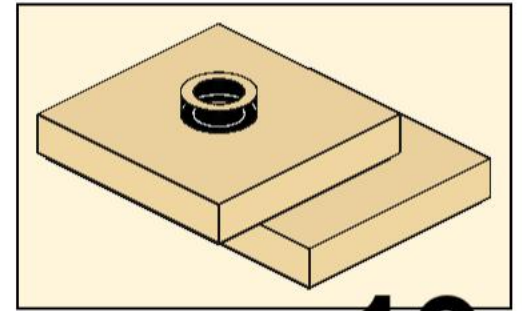
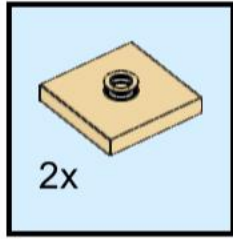

19x

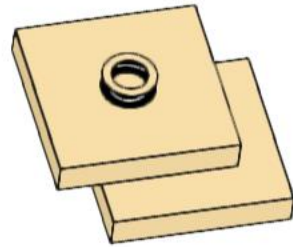

17

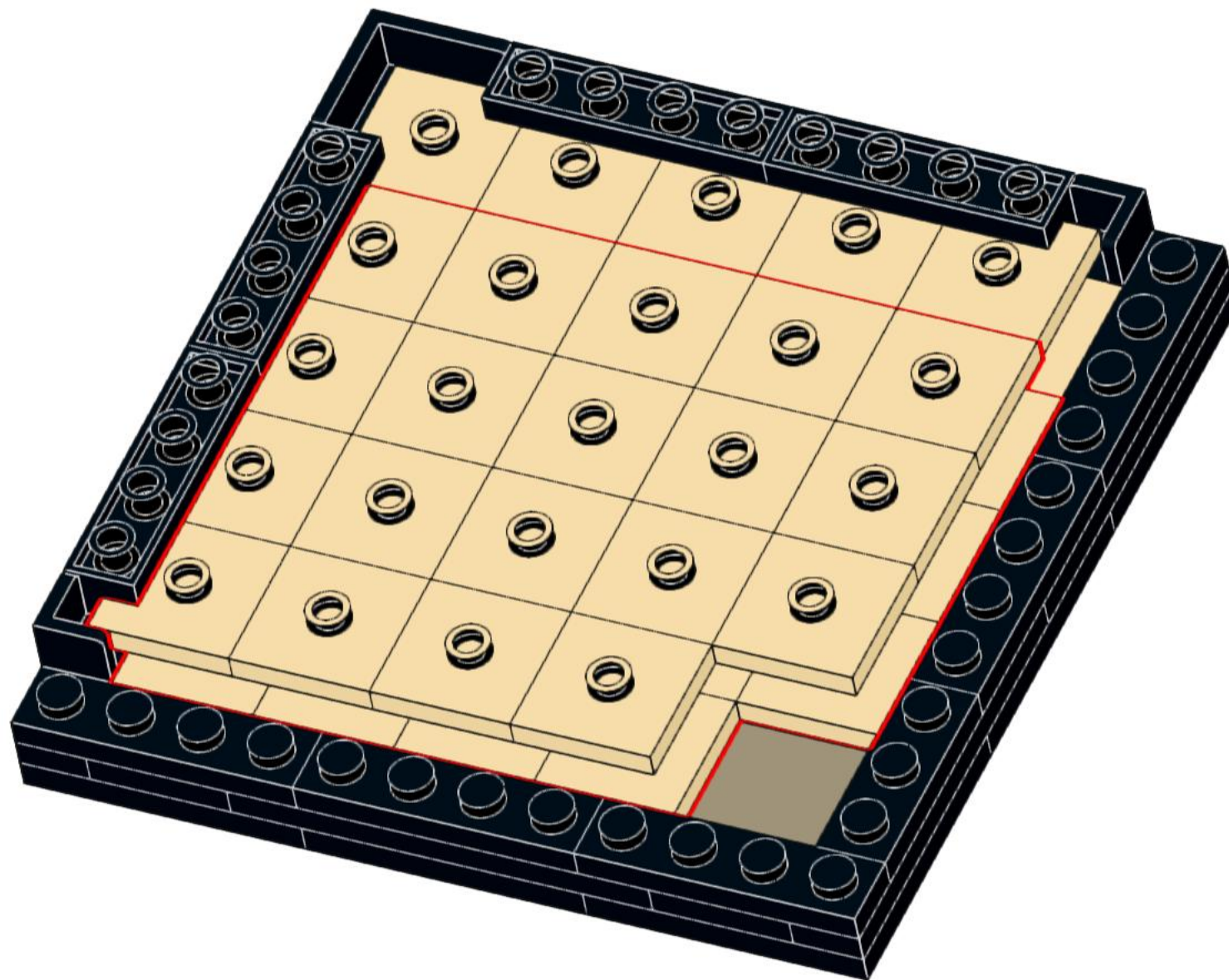

18

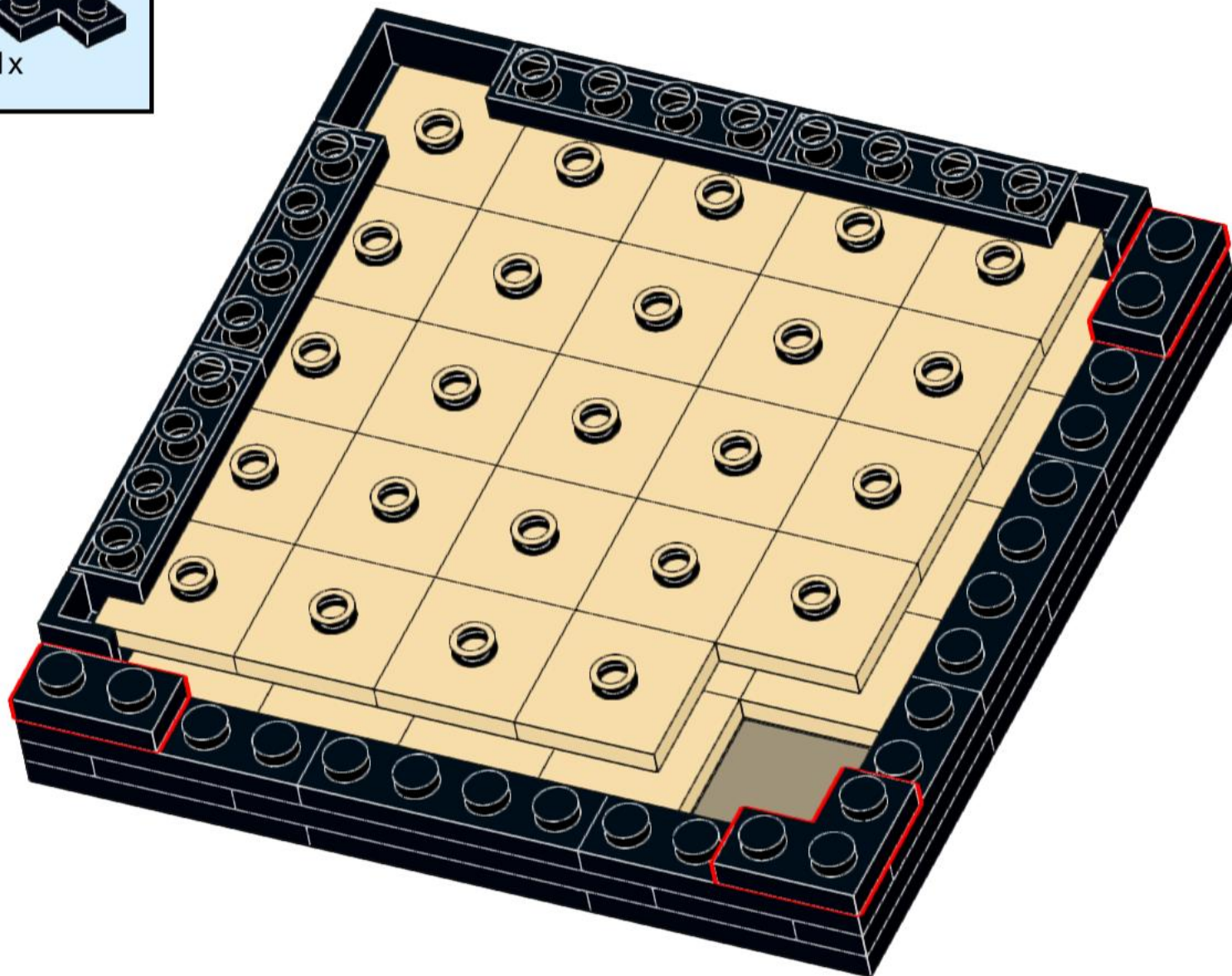
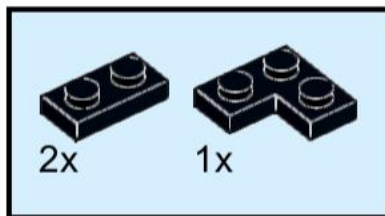

19

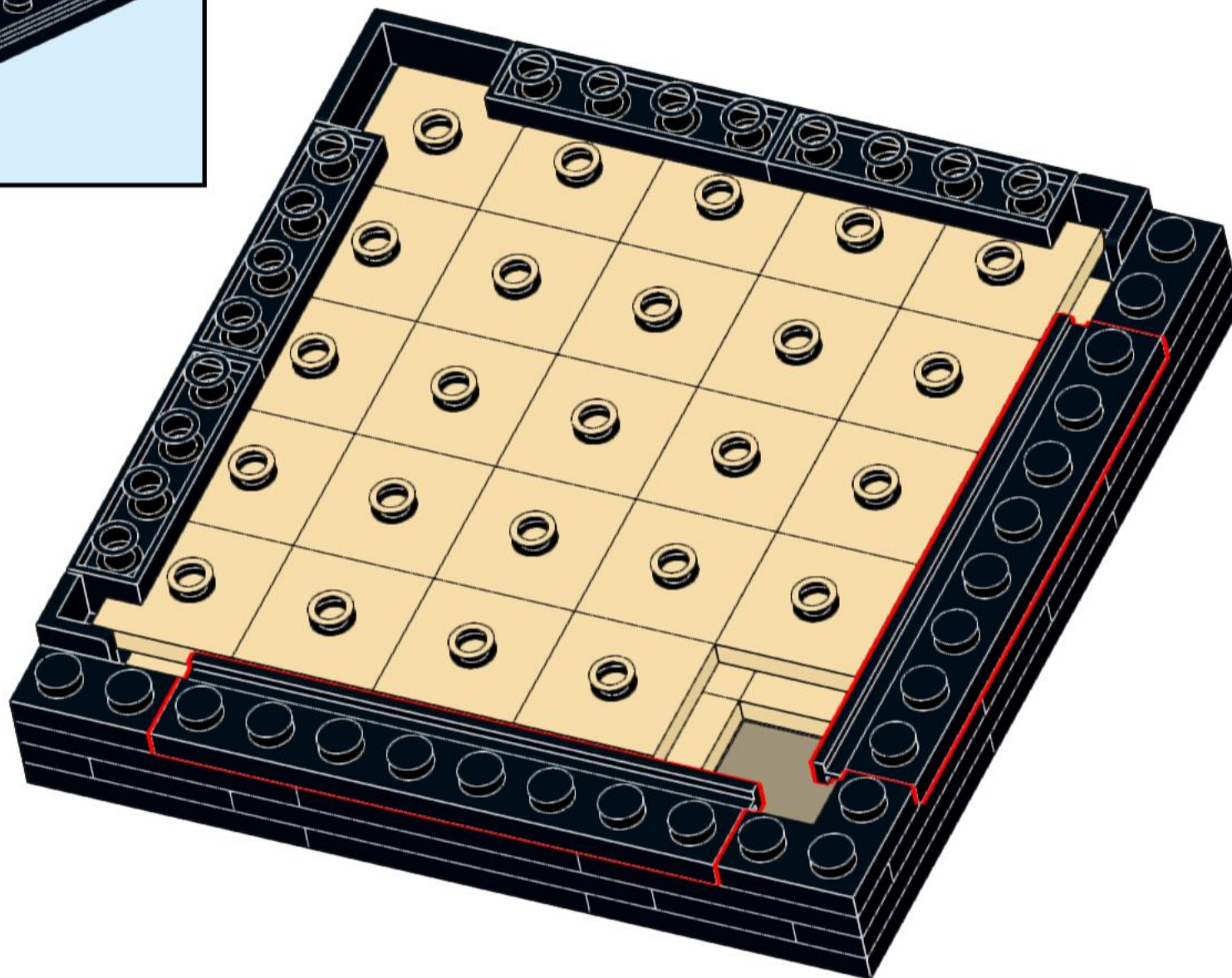
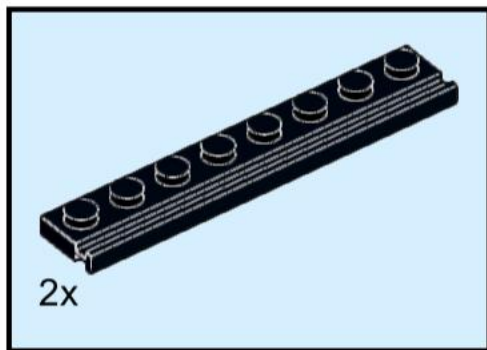

20

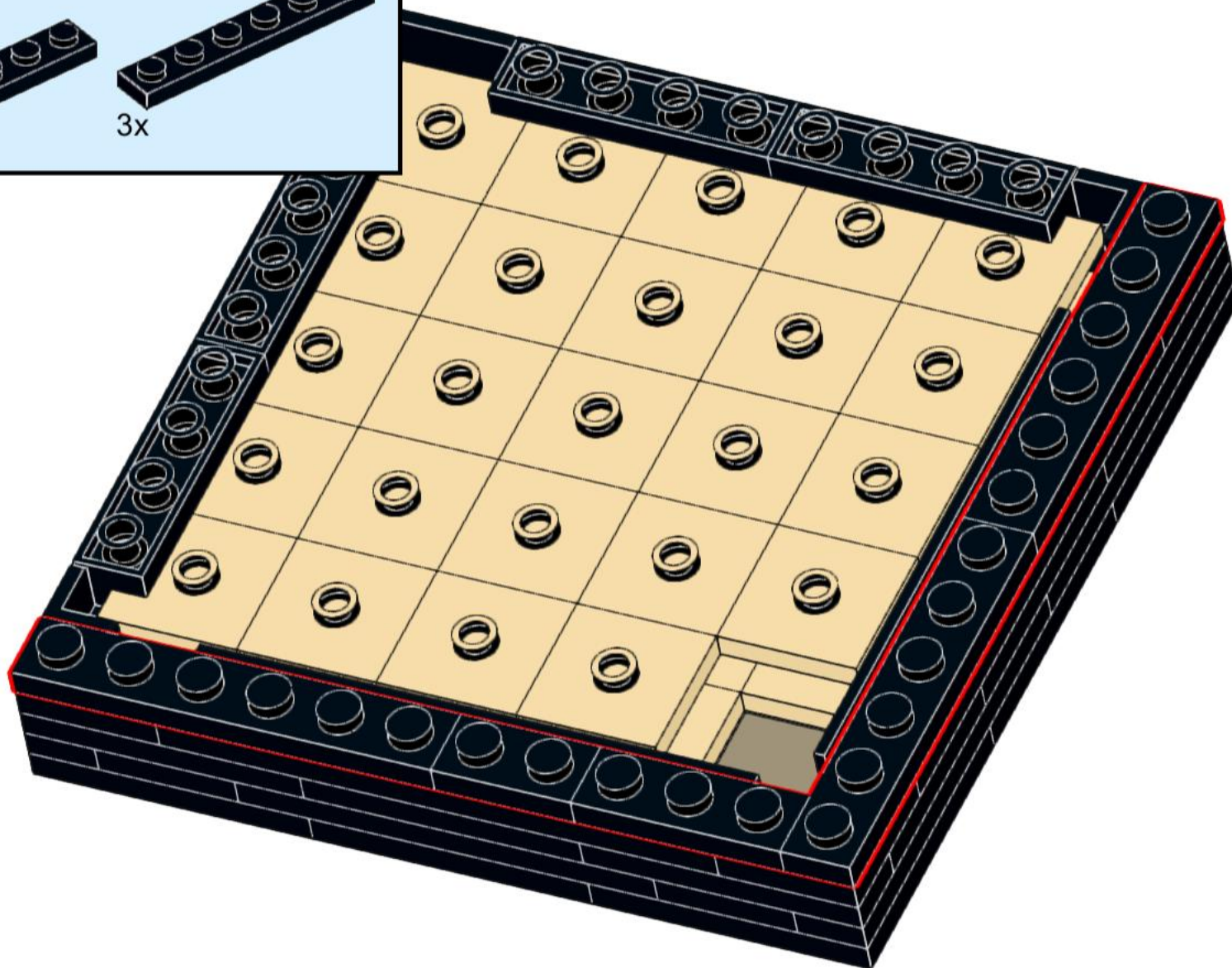
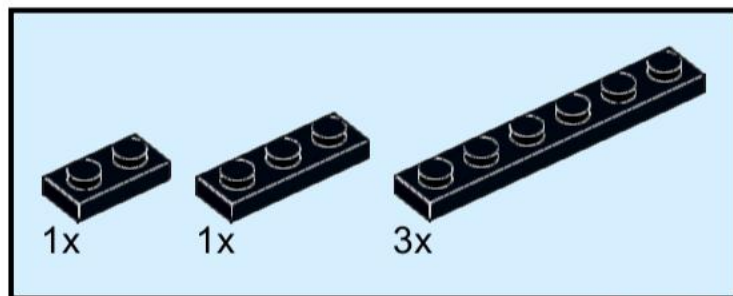

21

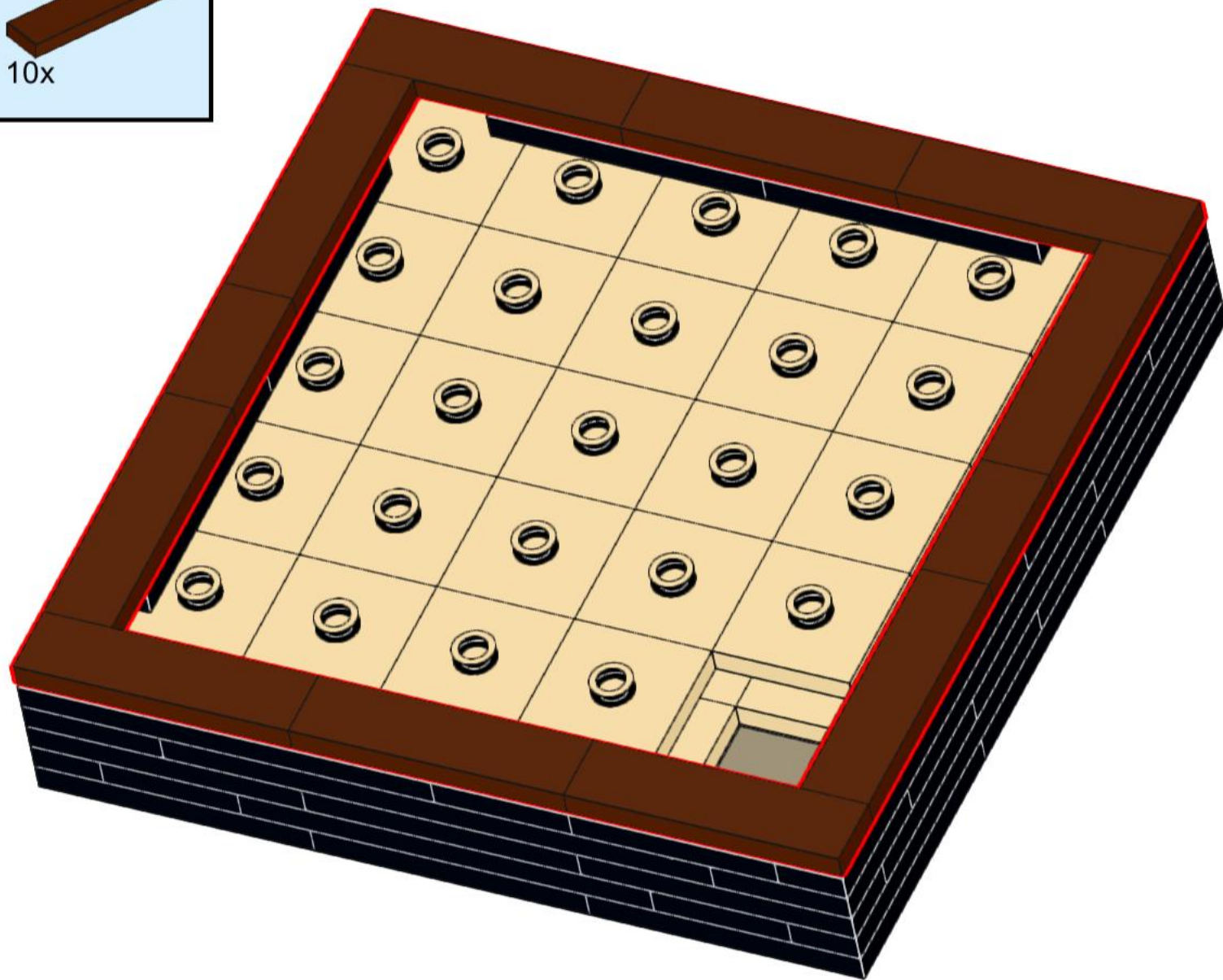
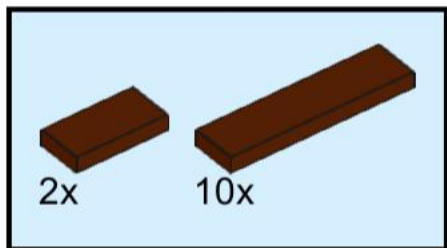

Example of final tile placement

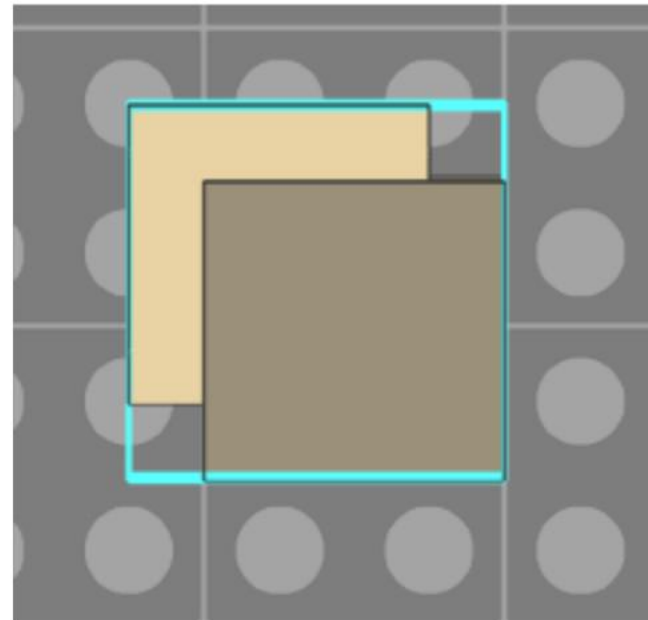
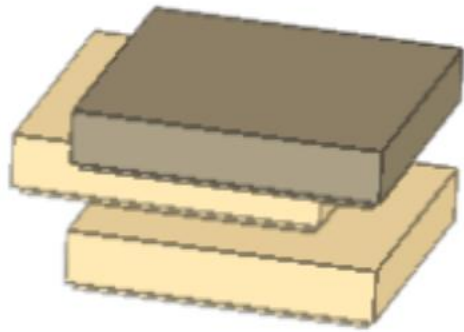

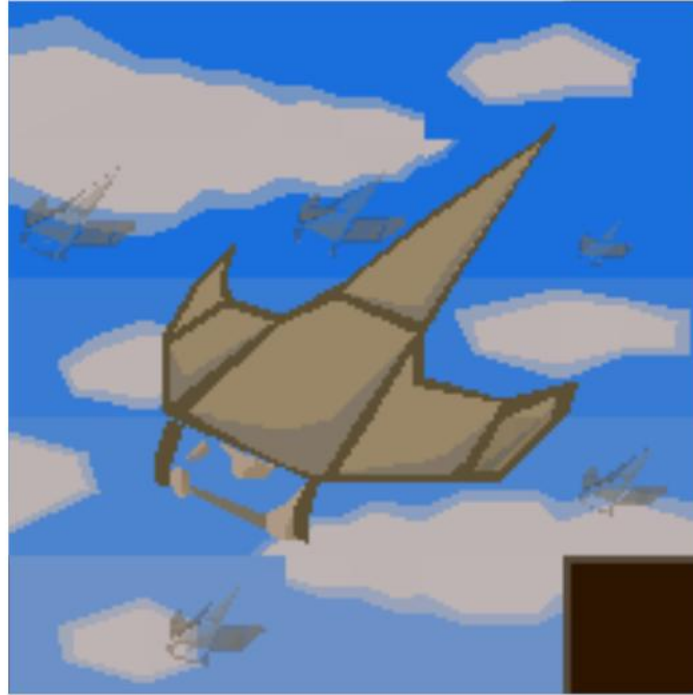

Reference Images Page 1



Reference Images Page 2



22

